

Prüfungszeichnung
quality test drawing

BaerFix®

Artikelnr.: <i>Item no.</i>	1-FE05
Bezeichnung: <i>Description:</i>	BaerFix® selbstschneidender Gewindeeinsatz BaerFix® Self-cutting Thread Insert
Typ: <i>Type:</i>	Schneidschlitze Cutting slots
Innengewinde D1: <i>Internal thread D1:</i>	M 5 x 0,8
Außengewinde D2: <i>External thread D2:</i>	M 8 x 1,0
Länge L1: <i>Length L1:</i>	10 mm
Richtung: <i>Direction:</i>	Rechts
Material: <i>Material:</i>	Einsatzgehärteter Stahl, verzinkt

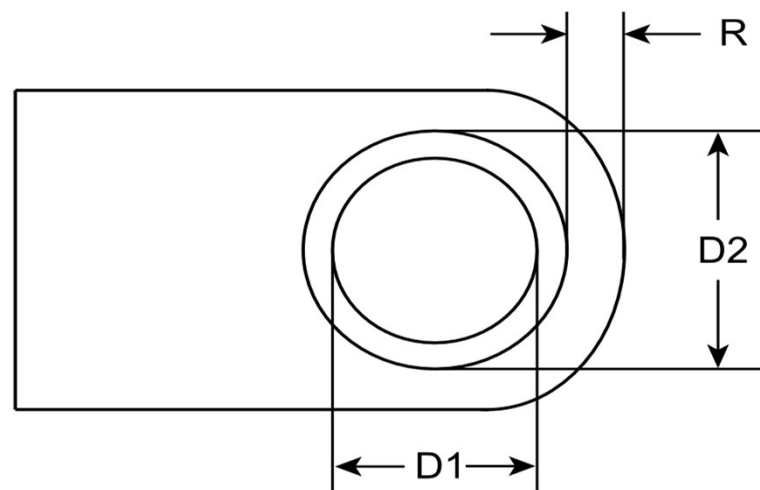
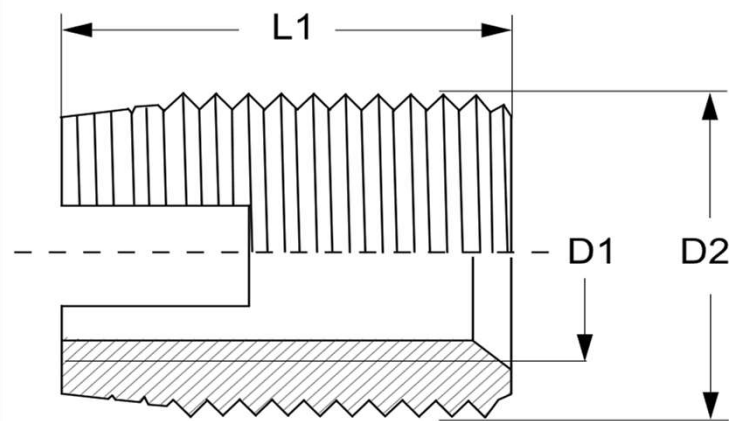

Vorbohrdurchmesser: <i>Pre-drilling diameter:</i>	Leichtmetall-Legierungen / Light metal alloys (unter 250 N/mm ²): 7,2 mm Leichtmetall-Legierungen / Light metal alloys (250 - 300 N/mm ²): 7,3 mm Leichtmetall-Legierungen / Light metal alloys (300 - 350 N/mm ²): 7,5 mm Leichtmetall-Legierungen / Light metal alloys (>350 N/mm ²): 7,6 mm Messing, NE-Metalle, Bronze / Brass, non-ferrous metals, bronze (>350 N/mm ²): 7,5 - 7,6 mm Gusseisen / Cast iron (<150 HB): 7,2 mm Gusseisen / Cast iron (150 - 200 HB): 7,3 - 7,5 mm
Mindestwandstärke: <i>Minimum wall thickness:</i>	R (min) (Leichtmetall / Light metal): 1,60 mm R (min) (Gusseisen / Cast iron): 2,40 mm R (min) (Kunststoff / Plastic): 2,00 mm
Minimale Bohrtiefe: <i>Minimum drilling depth:</i>	Durchgangsloch / through hole: 10,00 mm Sackloch / blind hole: 13,00 mm
Toleranz: <i>Tolerance:</i>	Produziert nach / produced acc. to: ISO 2768-m Innengewinde / Internal thread: ISO2/6H Außengewinde / External thread: Medium Tol.
Drehzahlrichtwert für Leichtmetalle: <i>Speed guide value for light metals:</i>	400-600 U/min
Maximales Eindrehmoment: <i>Maximum installation torque:</i>	10 Nm