

**Prüfungszeichnung**  
*quality test drawing*

**BaerFix®**

<b>Artikelnr.:</b> <i>Item no.</i>	1-FELL06
<b>Bezeichnung:</b> <i>Description:</i>	BaerFix® selbstschneidender Gewindeeinsatz BaerFix® Self-cutting Thread Insert
<b>Typ:</b> <i>Type:</i>	Schneidbohrungen Cutting holes
<b>Innengewinde D1:</b> <i>Internal thread D1:</i>	M 6 x 1,0
<b>Außengewinde D2:</b> <i>External thread D2:</i>	M 10 x 1,25
<b>Länge L1:</b> <i>Length L1:</i>	12 mm
<b>Richtung:</b> <i>Direction:</i>	Rechts
<b>Material:</b> <i>Material:</i>	Einsatzgehärteter Stahl, verzinkt

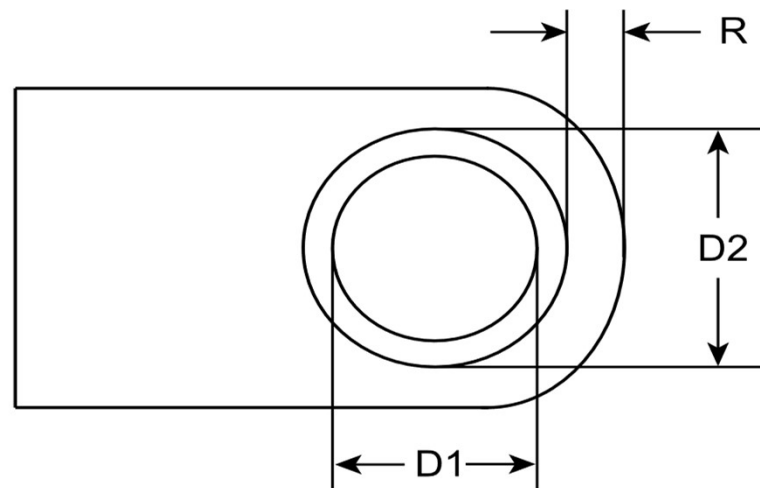
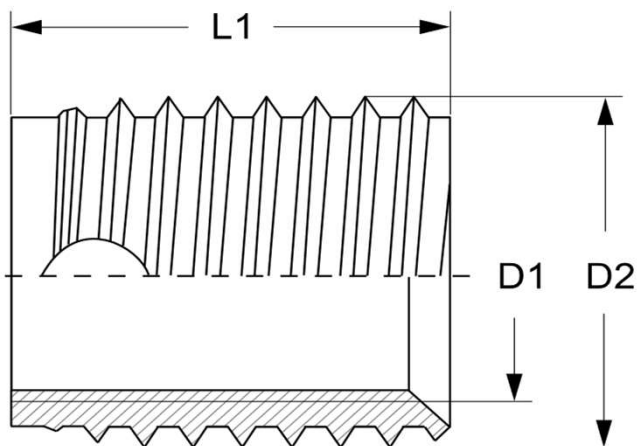

<b>Vorbohrdurchmesser:</b> <i>Pre-drilling diameter:</i>	Leichtmetall-Legierungen / Light metal alloys (unter 250 N/mm <sup>2</sup> ): 9,3 mm Leichtmetall-Legierungen / Light metal alloys (250 - 300 N/mm <sup>2</sup> ): 9,4 mm Leichtmetall-Legierungen / Light metal alloys (300 - 350 N/mm <sup>2</sup> ): 9,5 mm Leichtmetall-Legierungen / Light metal alloys (>350 N/mm <sup>2</sup> ): 9,6 mm Messing, NE-Metalle, Bronze / Brass, non-ferrous metals, bronze (>350 N/mm <sup>2</sup> ): 9,5 - 9,6 mm Gusseisen / Cast iron (<150 HB): 9,3 mm Gusseisen / Cast iron (150 - 200 HB): 9,4 - 9,5 mm
<b>Mindestwandstärke:</b> <i>Minimum wall thickness:</i>	R (min) (Leichtmetall / Light metal): 2,00 mm R (min) (Gusseisen / Cast iron): 3,00 mm R (min) (Kunststoff / Plastic): 2,50 mm
<b>Minimale Bohrtiefe:</b> <i>Minimum drilling depth:</i>	Durchgangsloch / through hole: 12,00 mm Sackloch / blind hole: 15,00 mm
<b>Toleranz:</b> <i>Tolerance:</i>	Produziert nach / produced acc. to: ISO 2768-m Innengewinde / Internal thread: ISO2/6H Außengewinde / External thread: Medium Tol.
<b>Drehzahlrichtwert für Leichtmetalle:</b> <i>Speed guide value for light metals:</i>	280-400 U/min
<b>Maximales Eindrehmoment:</b> <i>Maximum installation torque:</i>	15 Nm